

DIMENSIONS

INCHES
MILLIMETERS

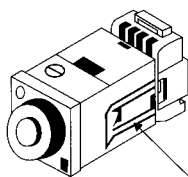

HOLD DOWN CLIP
ATC P/N 04070251300

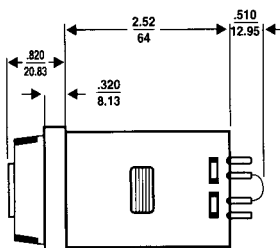
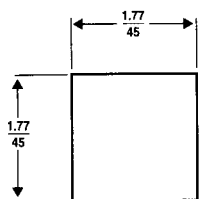
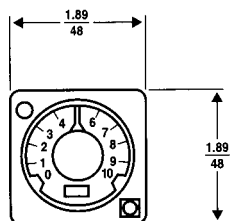
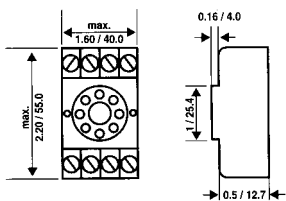

8 PIN SURFACE/DIN SOCKET
ATC P/N 00008258500

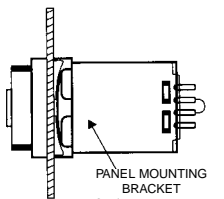

PANEL MOUNTING BRACKET
ATC P/N 0405-320-02-00

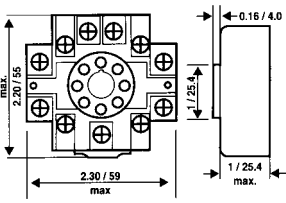

11 PIN SURFACE/DIN SOCKET
ATC P/N 00008258600

PANEL MOUNTING (UP TO .188 THICK)

FEATURES

- True Off-Delay mode of operation.
- Output contacts rated 10A at 120/240 VAC
- Three timing ranges in a single unit:
10 sec., 1 min., 10 min.
5 sec., 0.5 min., 5 min.
- Universal power operation:
24 VAC to 240 VAC and 24 VDC
- 8-Pin or 11-Pin mounting.
- Remote reset models.
- 48mm² DIN standard housing
- Watertight when panel-mounted
- Range selection is tamper-proof when panel-mounted.

Series 417

1/16 DIN True Off-Delay Timer



The 417B Directly Replaces 417A.

PRODUCT HIGHLIGHTS

TRUE OFF-DELAY OPERATION

When power is applied to the timer, the relay energizes and the indicating LED turns on. When power is removed, the timing starts and the LED turns off. The output relay remains energized until the end of the cycle, or by connecting terminal 1 to terminal 4 when using the remote reset model.

UNIVERSAL POWER SUPPLY

Each 417B can be powered from 24VAC to 240VAC and 24VDC, greatly simplifying ordering and inventory management.

INDUSTRIAL SERVICE DESIGN

The 417B is designed for the most rugged industrial environments. It offers exceptional electrical noise immunity, with excellent setting and repeat accuracy.

48mm² DIN HOUSING

The 48mm² (1/16 DIN) housing is compact and watertight when panel-mounted. The 417B is mounted in an 8-pin octal or 11-pin round socket. The 417B can be panel-mounted with an optional mounting clip.

A large time-setting knob is provided for easy adjustment by operator.

The range select switch is located on the side of the unit; therefore, once panel-mounted, the switch is not accessible to the operator. This tamper-proof feature prevents unauthorized or hazardous changes to the timing range.

POWER ON INDICATOR

The 417's high intensity LED turns on when power is applied to the timer. It turns off during timing.

APPROVALS

See agency listing on page 391.

OPERATION

When power is applied to the timer, the relay energizes and the indicating LED turns on. Timing starts when power is removed, and the LED turns off. The output relay remains energized until the end of the cycle, or by connecting terminals 1 to 4 when using the Remote Reset Model.

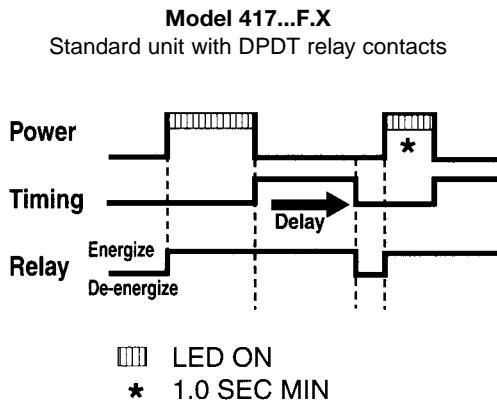

Model 417...F.R
Same as standard unit except with SPDT relay contacts and ability to reset from an externally located remote reset switch

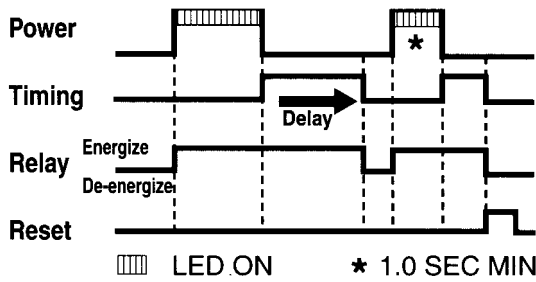

TYPICAL APPLICATIONS

Whenever main power is interrupted, the 417B (adjustable from 0.1 SEC to 10 MIN), enables an emergency backup power source.

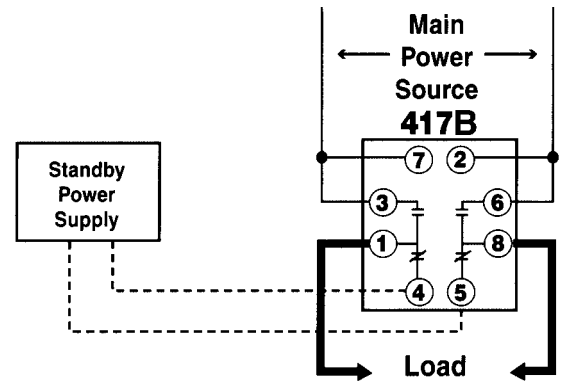

Controlled by a PLC, the 417B timing cycle can be aborted by using the remote reset terminals.

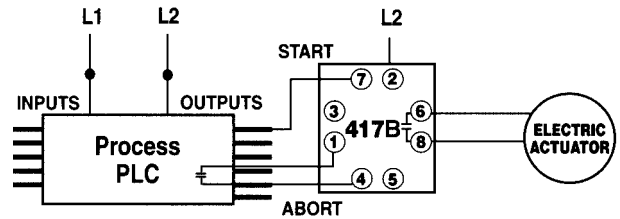

TERMINAL WIRING

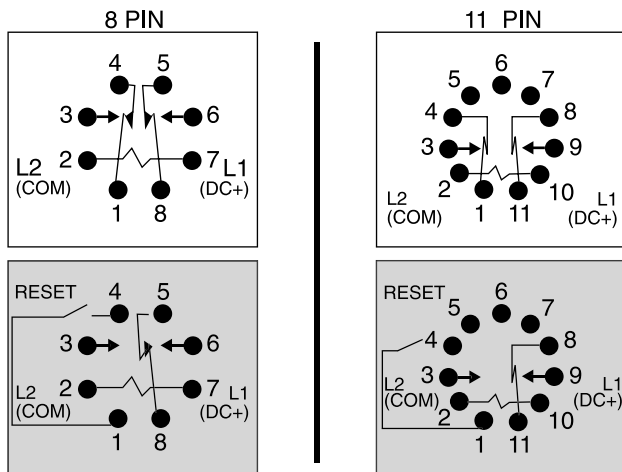

Bottom view of TDR

SETTING THE RANGE

Refer to the drawing. Using a small screwdriver inserted into the adjusting slot as shown (fig. 1), rotate the range switch. The selected range will appear through the window of the dial face.

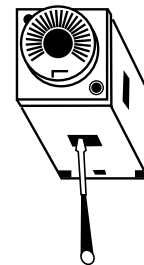

Before starting your design, read the safety statement on the inside back cover of the ATC catalog.

SPECIFICATIONS

MODELS

Choice of eight multi-range units.
Each model has three timing ranges.

RANGE

Model 417B100...(10 sec, 1 min, 10 min)
Model 417B500...(5 sec, 0.5 min, 5 min)

MINIMUM SETTING

2% of range

SETTING ACCURACY

+/-10%

POWER REQUIREMENTS

24 to 240 VAC & 24 VDC, 50 or 60 Hz,
(+10%, -20%) 24 to 240 VAC.

(+20%, -20%) 24 VDC

DC MAXIMUM RIPPLE AT 60 Hz-5%

LOAD RELAY

TYPE: DPDT, Standard Models
SPDT, Remote Reset Models

LIFE: 10,000,000 operations (no load)
100,000 operations with
5 AMPS at 30 VDC (or less) or
5 AMPS at 250 VAC (or less)

CONTACT RATING:

10 AMPS (Resistive @ 250 VAC)
1/3HP @ 120 VAC

HOUSING

48mm² (1/16 DIN) housing is watertight
when panel mounted.

REPEAT ACCURACY

+/-5%*

*variation from avg. actual time

TEMPERATURE RATING

-18° to 40° C
0° to 104° F

NOISE IMMUNITY

Showering Arc per NEMA 2-230, the 417
will withstand a voltage surge of 4500
volts for 50 micro seconds without damage.

REMOTE RESET

50 ms minimum
(remote reset models)

POWER ON TIME

1.0 sec minimum

INDICATOR

Power on LED

MOUNTING

Plug in base available in 8-Pin Octal or
11-Pin Round Base

OPTIONS: Surface Mounting Socket
DIN Rail Mounting Socket
Panel Mounting Kit
Plug-in Socket Kit

WEIGHT

NET: 5 oz.
SHIPPING: 1 lb.

ORDERING CODE

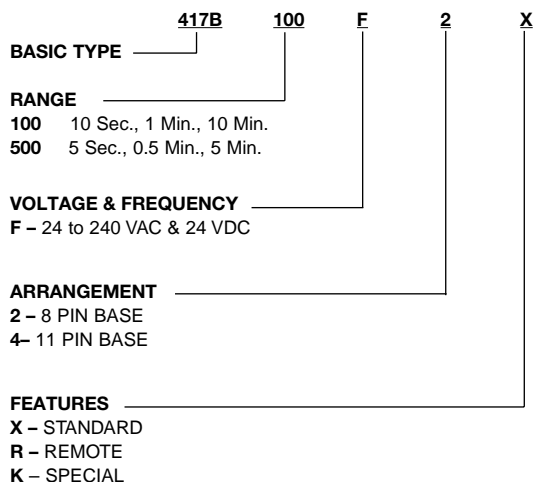

ACCESSORIES

8-PIN

0000-825-85-00 8-Pin surface/DIN rail socket
0000-825-87-00 8-Pin panel socket w/rear facing terminals
0319-261-45-00 Plug-in socket kit (8-pin)
0405-320-02-00 Panel mounting bracket
0407-025-13-00 Hold down clips for 0000-825-85-00 socket

11-PIN

0000-825-86-00 11-Pin surface/DIN rail socket
0000-825-88-00 11-Pin panel socket w/rear facing terminals
0314-260-07-00 Plug-in socket kit (11-pin)
0405-320-02-00 Panel mounting bracket
0407-025-13-00 Hold down clips for 0000-825-86-00 socket