

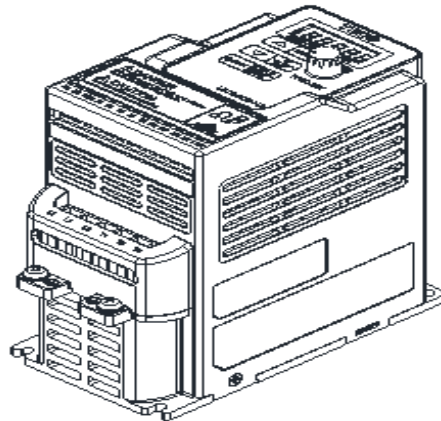

## GENERAL DATASHEET VARIABLE SPEED DRIVE

Series <b>L510</b>		MODEL# <b>L510-201-H3-U</b>		
ISSUED <b>3/26/2018</b>		ENCLOSURE/ FRAME <b>Chassis (IP20/00)/ F1</b>		
INPUT AMPS HD (CT) <b>6.4</b>		AC INPUT VOLTAGE <b>230</b>	AC INPUT FREQUENCY <b>50/60</b>	AC INPUT PHASE <b>3</b>
OUTPUT HP HD (CT) <b>1</b>	OUTPUT AMPS HD (CT) <b>4.3</b>	AC OUTPUT VOLTAGE <b>0-230</b>	AC OUTPUT FREQUENCY <b>0-599</b>	AC OUTPUT PHASE <b>3</b>

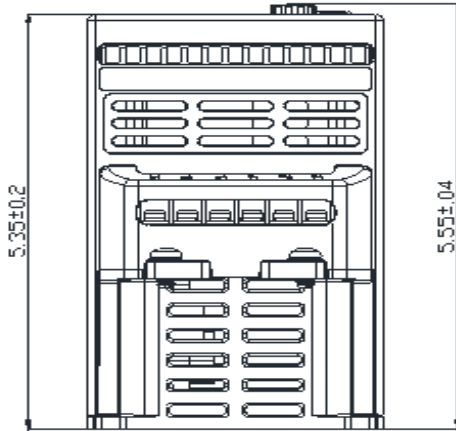
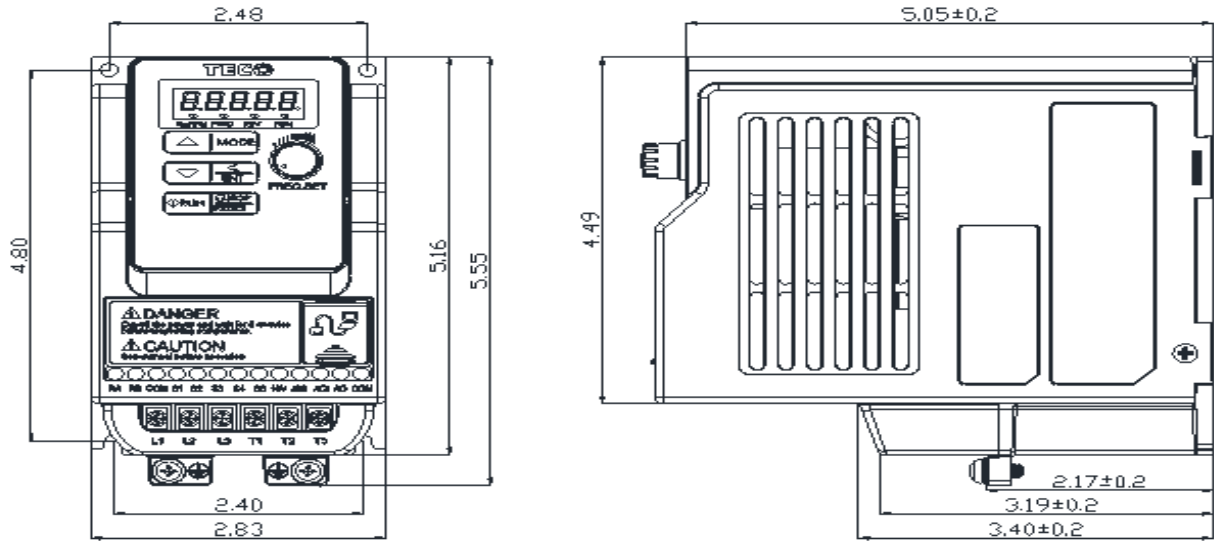

Approved By:	Brian Smith	Drawing No:	L510-230-201-F1	Revision: 1
--------------	-------------	-------------	-----------------	-------------